

Product title:

RECTANGULAR SECTION RINGS FOR HOLES M23LE7767

Product image:

Product price:

€2.22

Product short description:

RECTANGULAR SECTION RINGS FOR HOLES
M23LE7767

Product features:

WIDTH (t): 0.8
OUTSIDE DIAMETER (Dy): 8.5
SHAFT DIAMETER (d1): 8
WIDE (b): 1
HOLE GROOVE DIAMETER (d2): 8.3

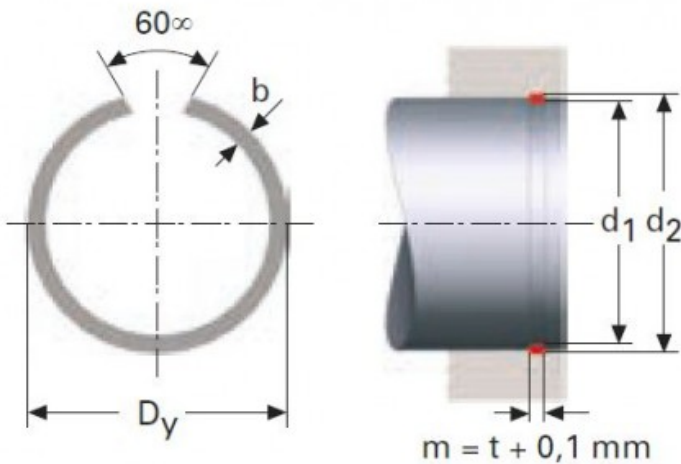

Product description:

RECTANGULAR SECTION RINGS FOR HOLES RSB

The rectangular cross-section of these retaining rings allows.

for higher loads than the round wire alternatives.

All dimensions are in mm.

Raw material steel CK 67.

Phosphated & slightly oiled.