

Product title:

# RECTANGULAR SECTION RINGS FOR SHAFTS

## RSW M23LE7754

Product image:

Product price:

**€6.00**

Product short description:

RECTANGULAR SECTION RINGS FOR SHAFTS RSW

Product features:

WIDTH (t): 1.5  
INSIDE DIAMETER: 42.8  
SHAFT DIAMETER (d1): 45  
WIDE (b): 2.3  
SHAFT GROOVE DIAMETER (d2): 43.5

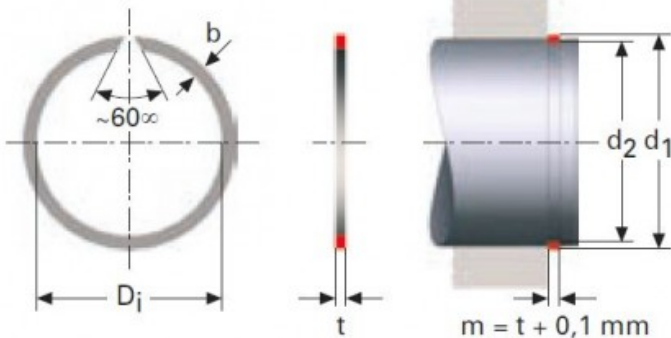

Product description:

RECTANGULAR SECTION RINGS FOR SHAFTS RSW

The rectangular cross-section of these retaining rings allows.

for higher loads than the round wire alternatives.

All dimensions are in mm.

Raw material steel CK 67.

Phosphated &amp; slightly oiled.