

Product title:

RECTANGULAR SECTION RINGS FOR SHAFTS

RSW M23LE7749

Product image:

Product price:

€4.50

Product short description:

RECTANGULAR SECTION RINGS FOR SHAFTS RSW

Product features:

WIDTH (t): 1.5
INSIDE DIAMETER: 30.2
SHAFT DIAMETER (d1): 32
WIDE (b): 2.3
SHAFT GROOVE DIAMETER (d2): 30.8

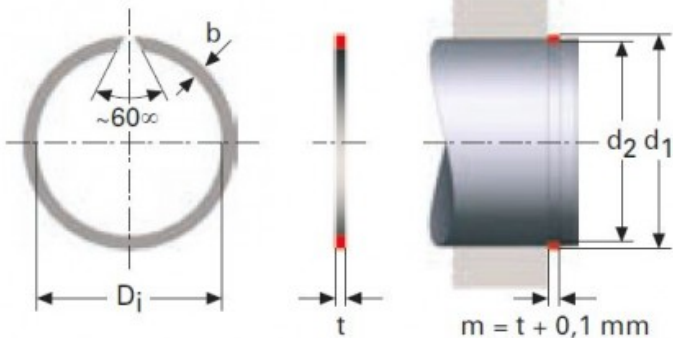

Product description:

RECTANGULAR SECTION RINGS FOR SHAFTS RSW

The rectangular cross-section of these retaining rings allows.

for higher loads than the round wire alternatives.

All dimensions are in mm.

Raw material steel CK 67.

Phosphated & slightly oiled.