

Product title:

RECTANGULAR SECTION RINGS FOR SHAFTS RSW M23LE7740

Product image:

Product price:

€2.52

Product short description:

RECTANGULAR SECTION RINGS FOR SHAFTS RSW

Product features:

WIDTH (t): 1.2
INSIDE DIAMETER: 15
SHAFT DIAMETER (d1): 16
WIDE (b): 1.75
SHAFT GROOVE DIAMETER (d2): 15.4

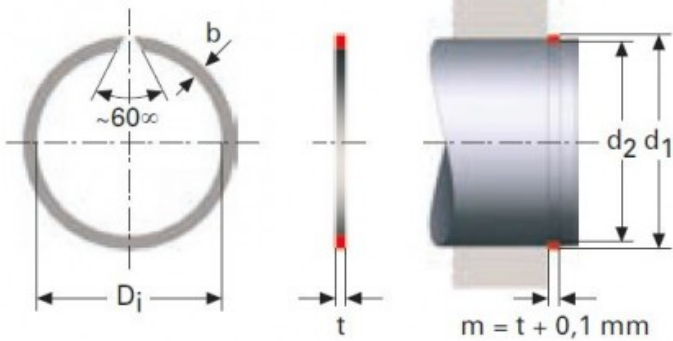

Product description:

RECTANGULAR SECTION RINGS FOR SHAFTS RSW

The rectangular cross-section of these retaining rings allows.

for higher loads than the round wire alternatives.

All dimensions are in mm.

Raw material steel CK 67.

Phosphated & slightly oiled.