

Product title:

CLOCK SPRING M20LE935

Product image:

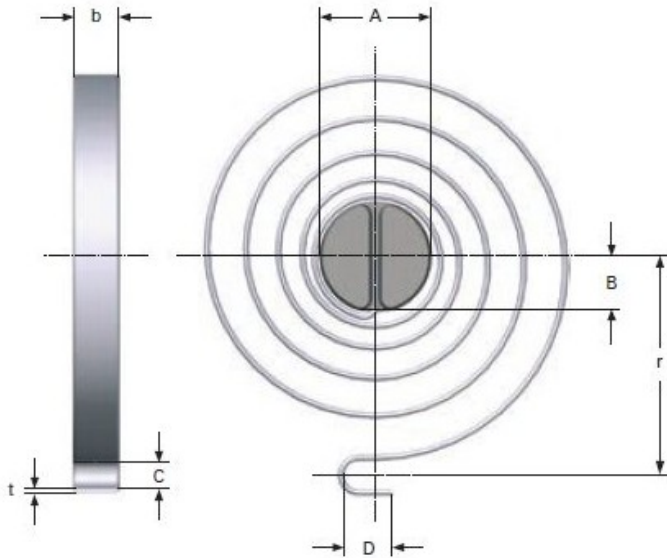

Product price:

€112.00

Product short description:

CLOCK SPRING

Product features:

TOTAL COILS: 8
RAW MATERIAL THICKNESS: 2.5
BAND WIDTH: 25
SHAFT DIAMETER: 28
LEG LENGTH: 10
TAIL WIDTH: 10.4
CENTER RADIO SPRING UNTIL FIXATION: 76
LONG TAIL HITCH: 15
RATE PER DEGREE OF TORQUE: 57
MAXIMUM TORQUE Nmm (10000): 33854
100000 CYCLES MAX. AT TORQUE ANGLE: 475
MAXIMUM TORQUE Nmm (100000): 27083
10035 CICLOS MAX. EN ANGULO DE TORSION: 594

Product description:

Clock springs made of stainless material according to EN 10270-3-1.4310

rounded edges to improve fatigue.

All dimensions are in mm