

Product title:

CLOCK SPRING M20LE928

Product image:

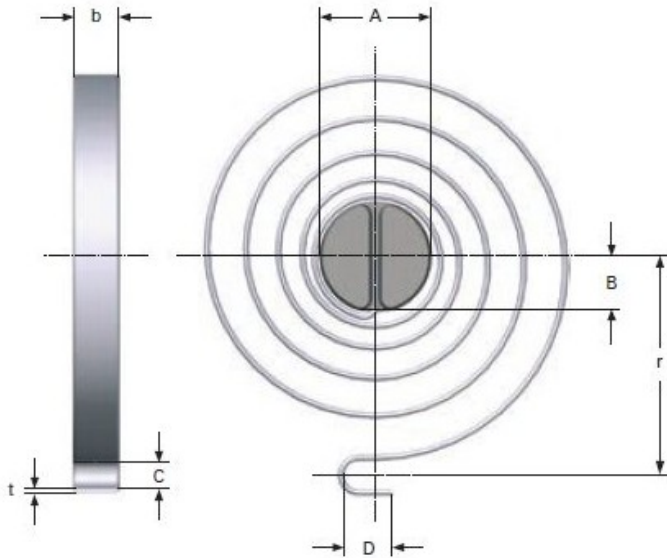

Product price:

€49.00

Product short description:

CLOCK SPRING

Product features:

TOTAL COILS: 5
RAW MATERIAL THICKNESS: 2
BAND WIDTH: 12
SHAFT DIAMETER: 24
LEG LENGTH: 8
TAIL WIDTH: 8.4
CENTER RADIO SPRING UNTIL FIXATION: 43
LONG TAIL HITCH: 12
RATE PER DEGREE OF TORQUE: 35.9
MAXIMUM TORQUE Nmm (10000): 11200
100000 CYCLES MAX. AT TORQUE ANGLE: 250
MAXIMUM TORQUE Nmm (100000): 8960
10028 CICLOS MAX. EN ANGULO DE TORSION: 312

Product description:

Clock springs made of stainless material according to EN 10270-3-1.4310

rounded edges to improve fatigue.

All dimensions are in mm