

Product title:

CLOCK SPRING M20LE926

Product image:

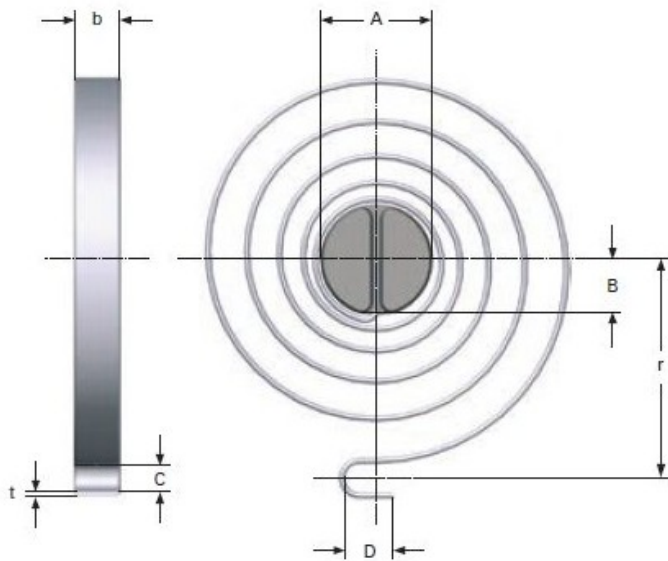

Product price:

€42.00

Product short description:

CLOCK SPRING

Product features:

TOTAL COILS: 8
RAW MATERIAL THICKNESS: 1.5
BAND WIDTH: 10
SHAFT DIAMETER: 20
LEG LENGTH: 7
TAIL WIDTH: 6.3
CENTER RADIO SPRING UNTIL FIXATION: 52
LONG TAIL HITCH: 9
RATE PER DEGREE OF TORQUE: 7.64
MAXIMUM TORQUE Nmm (10000): 5400
100000 CYCLES MAX. AT TORQUE ANGLE: 565
MAXIMUM TORQUE Nmm (100000): 4320
10026 CICLOS MAX. EN ANGULO DE TORSION: 706

Product description:

Clock springs made of stainless material according to EN 10270-3-1.4310

rounded edges to improve fatigue.

All dimensions are in mm