

Product title:

CLOCK SPRING M20LE917

Product image:

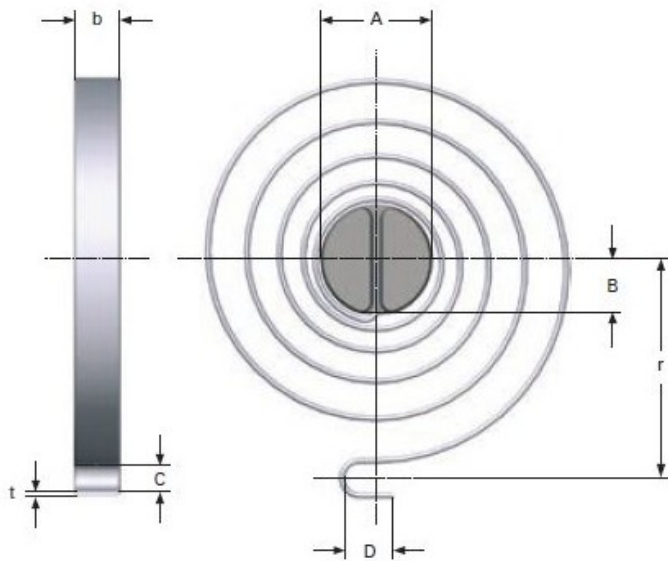

Product price:

€22.00

Product short description:

CLOCK SPRING

Product features:

TOTAL COILS: 5
RAW MATERIAL THICKNESS: 1
BAND WIDTH: 10
SHAFT DIAMETER: 14
LEG LENGTH: 5
TAIL WIDTH: 5.2
CENTER RADIO SPRING UNTIL FIXATION: 25
LONG TAIL HITCH: 7
RATE PER DEGREE OF TORQUE: 6.66
MAXIMUM TORQUE Nmm (10000): 2500
100000 CYCLES MAX. AT TORQUE ANGLE: 300
MAXIMUM TORQUE Nmm (100000): 2000
10017 CICLOS MAX. EN ANGULO DE TORSION: 375

Product description:

Clock springs made of stainless material according to EN 10270-3-1.4310

rounded edges to improve fatigue.

All dimensions are in mm