

Product title:

CLOCK SPRING M20LE908

Product image:

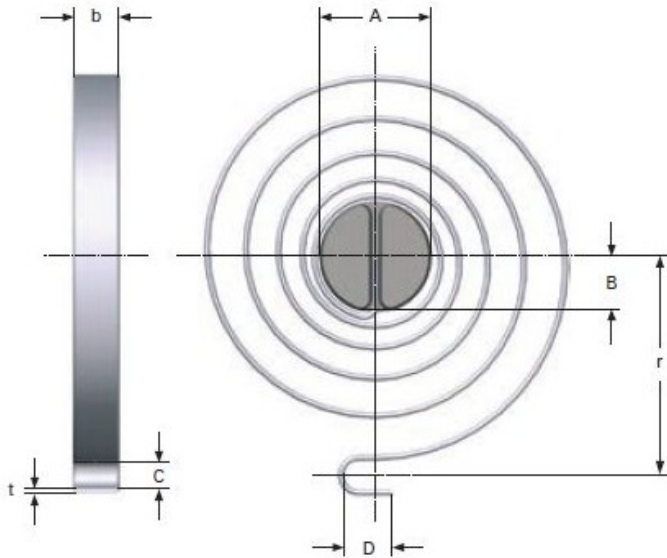

Product price:

€13.00

Product short description:

CLOCK SPRING

Product features:

TOTAL COILS: 5
RAW MATERIAL THICKNESS: 0.7
BAND WIDTH: 4
SHAFT DIAMETER: 10
LEG LENGTH: 3.5
TAIL WIDTH: 3.7
CENTER RADIO SPRING UNTIL FIXATION: 19
LONG TAIL HITCH: 5
RATE PER DEGREE OF TORQUE: 1.43
MAXIMUM TORQUE Nmm (10000): 506
100000 CYCLES MAX. AT TORQUE ANGLE: 283
MAXIMUM TORQUE Nmm (100000): 405
10008 CICLOS MAX. EN ANGULO DE TORSION: 354

Product description:

Clock springs made of stainless material according to EN 10270-3-1.4310

rounded edges to improve fatigue.

All dimensions are in mm