

Product title:

# CLOCK SPRING M20LE903

Product image:

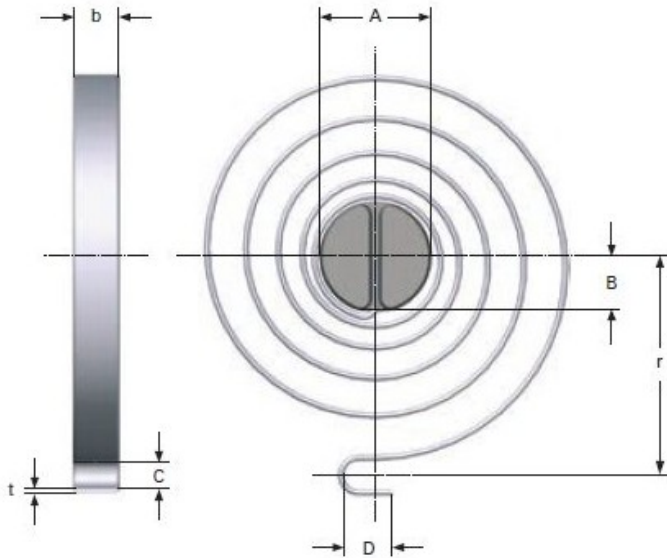

Product price:

**€16.00**

Product short description:

CLOCK SPRING

Product features:

TOTAL COILS: 8  
RAW MATERIAL THICKNESS: 0.5  
BAND WIDTH: 5  
SHAFT DIAMETER: 7  
LEG LENGTH: 2.5  
TAIL WIDTH: 2.7  
CENTER RADIO SPRING UNTIL FIXATION: 21  
LONG TAIL HITCH: 3.5  
RATE PER DEGREE OF TORQUE: 0.43  
MAXIMUM TORQUE Nmm (10000): 329  
100000 CYCLES MAX. AT TORQUE ANGLE: 610  
MAXIMUM TORQUE Nmm (100000): 263  
10003 CICLOS MAX. EN ANGULO DE TORSION: 762

Product description:

Clock springs made of stainless material according to EN 10270-3-1.4310

rounded edges to improve fatigue.

All dimensions are in mm