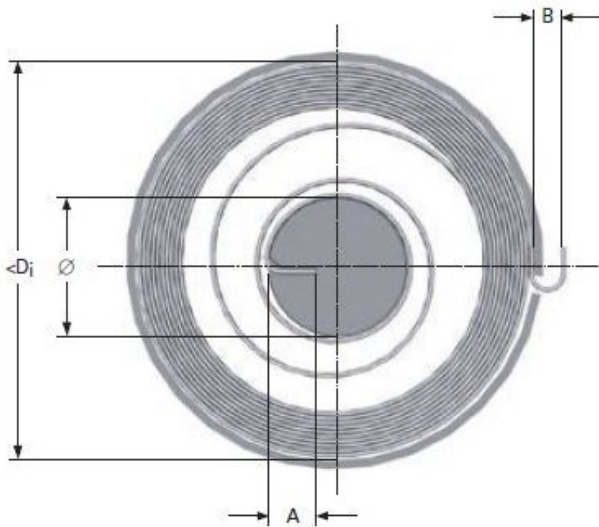

Product title:

MOTOR SPRING M16LE61733

Product image:

Product price:

€196.02

Product short description:

MOTOR SPRING M16LE61733

Product features:

INSIDE DIAMETER: 157
TOTAL COILS: 20
RAW MATERIAL THICKNESS: 0.56
BAND WIDTH: 20
SHAFT DIAMETER: 25
LEG LENGTH: 7
TORQUE: 660
MAXIMUM TORQUE: 2070
TAIL WIDTH: 6