

Product title:

MOTOR SPRING M16LE61731

Product image:

Product price:

€154.88

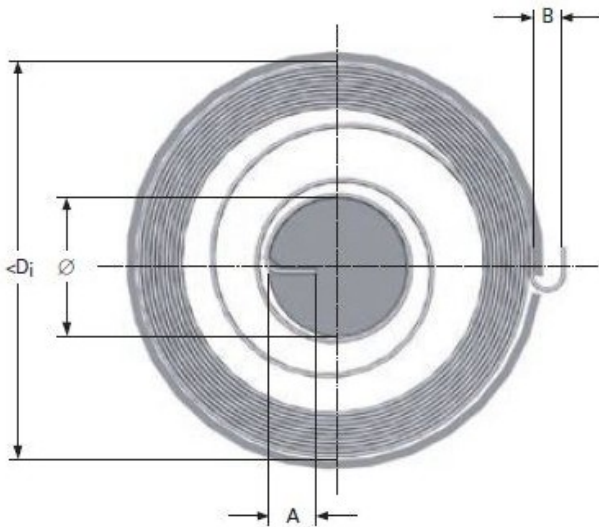

Product short description:

MOTOR SPRING M16LE61731

Product features:

INSIDE DIAMETER: 157
TOTAL COILS: 20
RAW MATERIAL THICKNESS: 0.56
BAND WIDTH: 12
SHAFT DIAMETER: 25
LEG LENGTH: 7
TORQUE: 400
MAXIMUM TORQUE: 1240
TAIL WIDTH: 6