

Product title:

MOTOR SPRING M16LE61729

Product image:

Product price:

€145.20

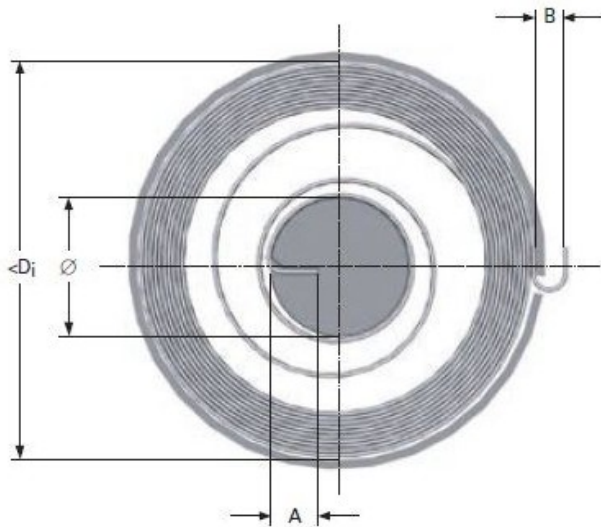

Product short description:

MOTOR SPRING M16LE61729

Product features:

INSIDE DIAMETER: 136
TOTAL COILS: 20
RAW MATERIAL THICKNESS: 0.47
BAND WIDTH: 15
SHAFT DIAMETER: 20
LEG LENGTH: 6
TORQUE: 370
MAXIMUM TORQUE: 1200
TAIL WIDTH: 6