

Product title:

MOTOR SPRING M16LE61727

Product image:

Product price:

€116.16

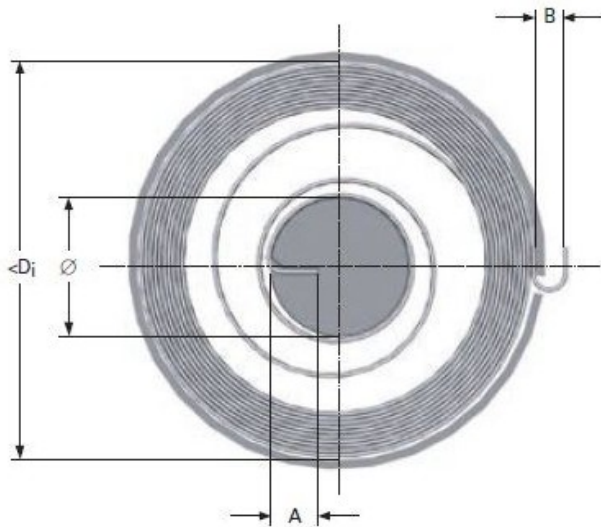

Product short description:

MOTOR SPRING M16LE61727

Product features:

INSIDE DIAMETER: 116
TOTAL COILS: 20
RAW MATERIAL THICKNESS: 0.4
BAND WIDTH: 15
SHAFT DIAMETER: 18
LEG LENGTH: 5
TORQUE: 280
MAXIMUM TORQUE: 890
TAIL WIDTH: 5