

Product title:

MOTOR SPRING M16LE9452

Product image:

Product price:

€463.62

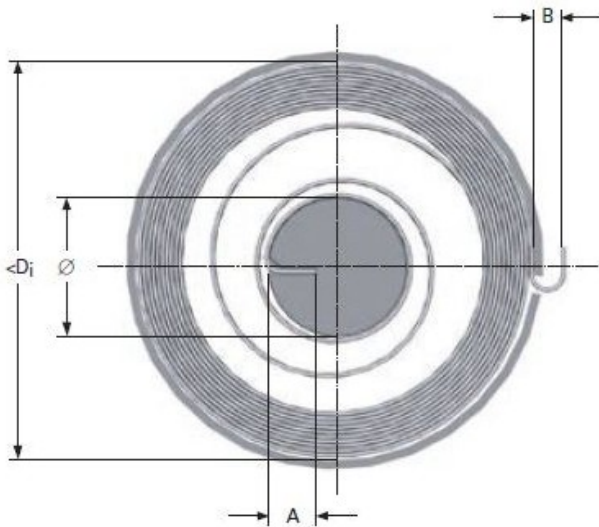

Product short description:

MOTOR SPRING M16LE9452

Product features:

INSIDE DIAMETER: 295
TOTAL COILS: 20
RAW MATERIAL THICKNESS: 1.5
BAND WIDTH: 25
SHAFT DIAMETER: 40
LEG LENGTH: 12
TORQUE: 1646
MAXIMUM TORQUE: 8457
TAIL WIDTH: 10