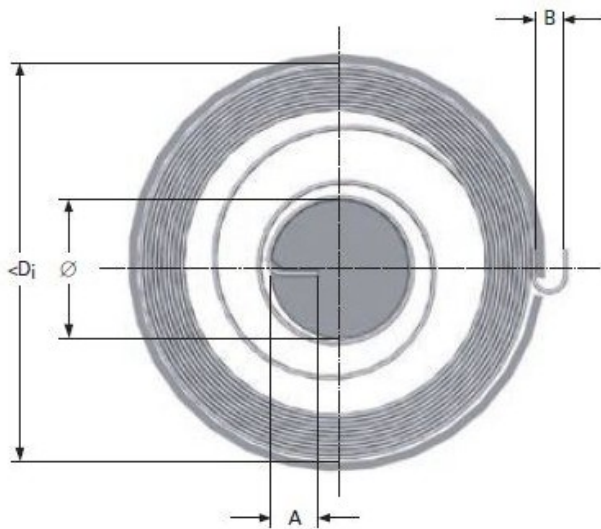

Product title:

MOTOR SPRING M16LE8992

Product image:

Product price:

€151.42

Product short description:

MOTOR SPRING M16LE8992

Product features:

INSIDE DIAMETER: 136
TOTAL COILS: 20
RAW MATERIAL THICKNESS: 0.7
BAND WIDTH: 12
SHAFT DIAMETER: 20
LEG LENGTH: 6
TORQUE: 184
MAXIMUM TORQUE: 942
TAIL WIDTH: 6