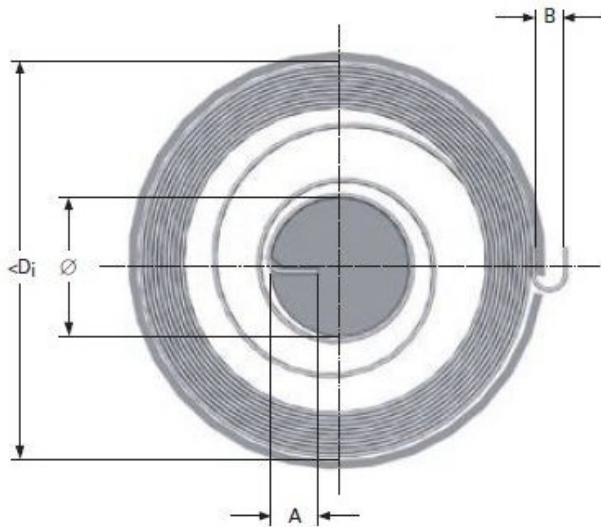

Product title:

MOTOR SPRING M16LE61714

Product image:

Product price:

€152.46

Product short description:

MOTOR SPRING M16LE61714

Product features:

INSIDE DIAMETER: 145
TOTAL COILS: 10
RAW MATERIAL THICKNESS: 0.66
BAND WIDTH: 15
SHAFT DIAMETER: 30
LEG LENGTH: 8
TORQUE: 920
MAXIMUM TORQUE: 2350
TAIL WIDTH: 8