

Product title:

# MOTOR SPRING M16LE61709

Product image:

Product price:

**€91.96**

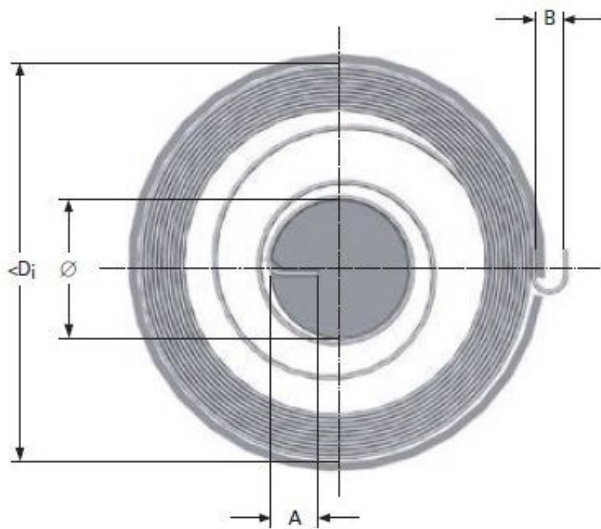

Product short description:

MOTOR SPRING M16LE61709

Product features:

INSIDE DIAMETER: 100  
TOTAL COILS: 10  
RAW MATERIAL THICKNESS: 0.47  
BAND WIDTH: 15  
SHAFT DIAMETER: 20  
LEG LENGTH: 6  
TORQUE: 450  
MAXIMUM TORQUE: 1180  
TAIL WIDTH: 6