

Product title:

MOTOR SPRING M16LE61708

Product image:

Product price:

€91.96

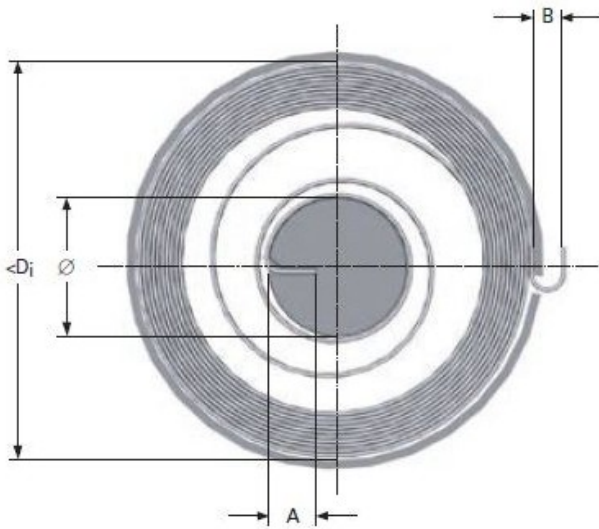

Product short description:

MOTOR SPRING M16LE61708

Product features:

INSIDE DIAMETER: 100
TOTAL COILS: 10
RAW MATERIAL THICKNESS: 0.47
BAND WIDTH: 12
SHAFT DIAMETER: 20
LEG LENGTH: 6
TORQUE: 360
MAXIMUM TORQUE: 950
TAIL WIDTH: 6