

Product title:

# MOTOR SPRING M16LE61706

Product image:

Product price:

**€72.60**

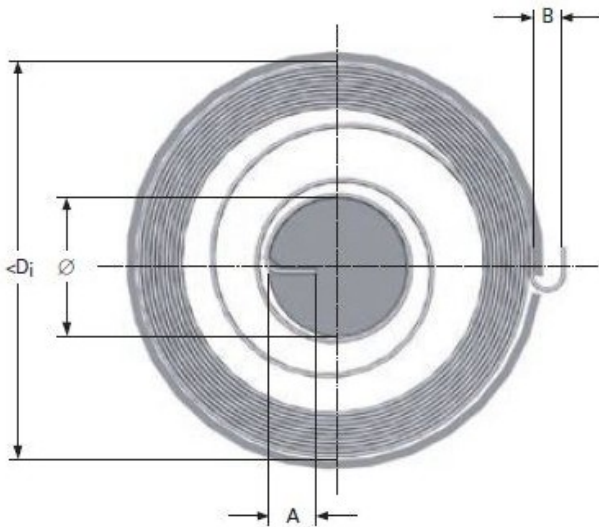

Product short description:

MOTOR SPRING M16LE61706

Product features:

INSIDE DIAMETER: 85  
TOTAL COILS: 10  
RAW MATERIAL THICKNESS: 0.4  
BAND WIDTH: 12  
SHAFT DIAMETER: 18  
LEG LENGTH: 5  
TORQUE: 280  
MAXIMUM TORQUE: 710  
TAIL WIDTH: 5