

Product title:

MOTOR SPRING M16LE8981

Product image:

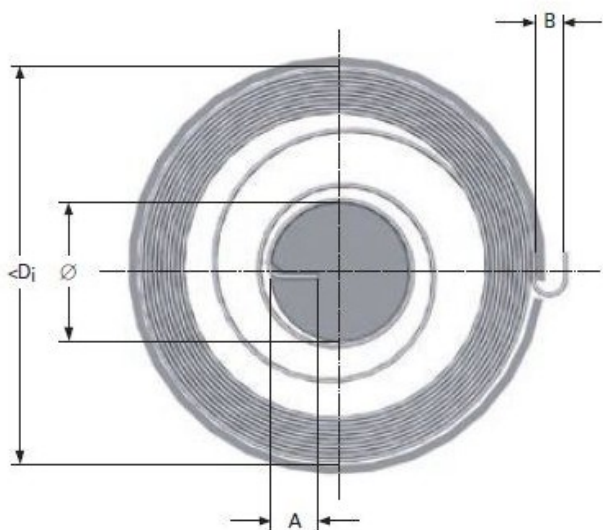

Product price:

€233.68

Product short description:

MOTOR SPRING M16LE8981

Product features:

INSIDE DIAMETER: 220
TOTAL COILS: 10
RAW MATERIAL THICKNESS: 1.5
BAND WIDTH: 20
SHAFT DIAMETER: 40
LEG LENGTH: 12
TORQUE: 1599
MAXIMUM TORQUE: 6713
TAIL WIDTH: 10