

Product title:

MOTOR SPRING M16LE8967

Product image:

Product price:

€49.54

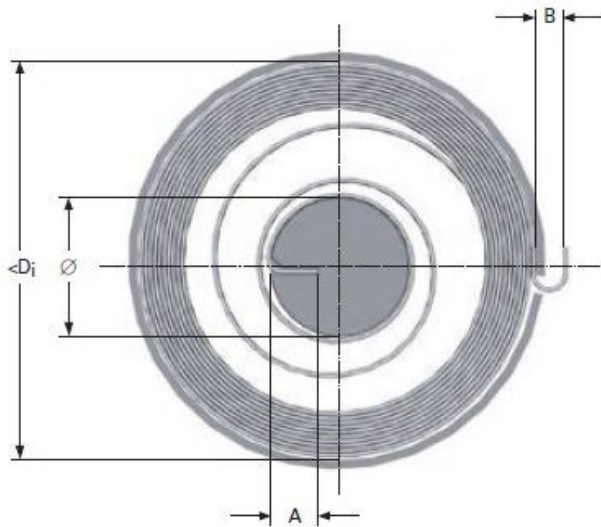

Product short description:

MOTOR SPRING M16LE8967

Product features:

INSIDE DIAMETER: 70
TOTAL COILS: 10
RAW MATERIAL THICKNESS: 0.5
BAND WIDTH: 12
SHAFT DIAMETER: 15
LEG LENGTH: 4
TORQUE: 124
MAXIMUM TORQUE: 503
TAIL WIDTH: 5