

Product title:

## Double torsion spring according to DIN 2089

Product image:

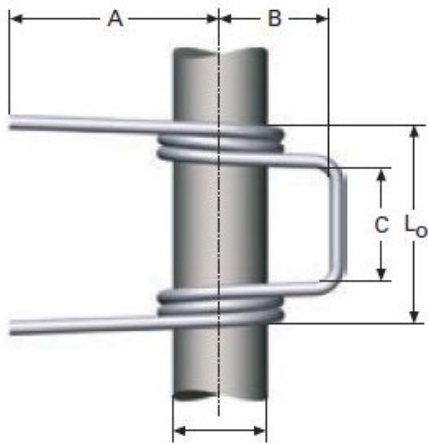

Product price:

**€51.30**

Product short description:

Muelle de doble torsion LEDT8608

Product features:

FREE ANGLE POSITION: B  
SKU: LEDT8608  
LENGTH LEGS: 100  
SHAFT DIAMETER: 30  
FRAME LENGTH: 50  
FRAME WIDTH: 36  
LENGTH BETWEEN LEGS: 66  
INSIDE DIAMETER: 34  
WIRE DIAMETER: 5  
RAW MATERIAL: EN 10270-3 1.4310  
COILS ON EACH BODY: 2.25  
MAXIMUM PERMITTED TORQUE: 25072  
TORQUE ANGLE AT MN (?): 32

Product description:

- Double torsion spring according to DIN 2089
- Brand name: LESJÖFORS Springs
- Raw material: Stainless steel;EN 10270-3-1.4310
- Cycles guarantee : Infinite if working without reaching yield point
- All measures are in N. and mm.

{tab Delivering time}

{article 8 days delivering time} {text} {/article}

{tab Technical information}

Coming soon

{tab Other informations}

{/tabs}