

Product title:

Double torsion spring according to DIN 2089

Product image:

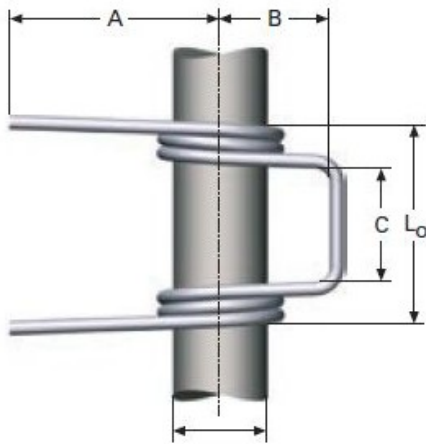

Product price:

€17.01

Product short description:

Muelle de doble torsion LEDT8578

Product features:

FREE ANGLE POSITION: C
SKU: LEDT8578
LENGTH LEGS: 45
SHAFT DIAMETER: 10
FRAME LENGTH: 16
FRAME WIDTH: 13
LENGTH BETWEEN LEGS: 34
INSIDE DIAMETER: 12
WIRE DIAMETER: 1.5
RAW MATERIAL: EN 10270-3 1.4310
COILS ON EACH BODY: 6.5
MAXIMUM PERMITTED TORQUE: 800
TORQUE ANGLE AT MN (?): 130

Product description:

- Double torsion spring according to DIN 2089
- Brand name: LESJÖFORS Springs
- Raw material: Stainless steel;EN 10270-3-1.4310
- Cycles guarantee : Infinite if working without reaching yield point
- All measures are in N. and mm.

{tab Delivering time}

{article 8 days delivering time} {text} {/article}

{tab Technical information}

Coming soon

{tab Other informations}

{/tabs}