

Product title:

## Double torsion spring according to DIN 2089

Product image:

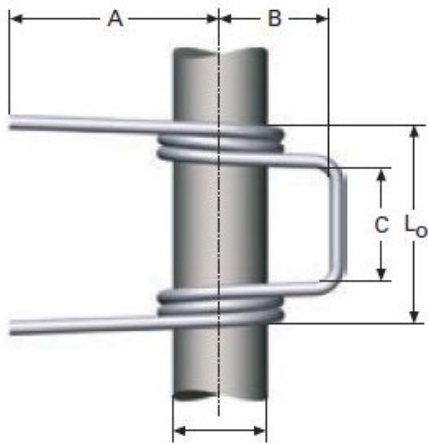

Product price:

**€15.34**

Product short description:

Muelle de doble torsion LEDT8574

Product features:

FREE ANGLE POSITION: C  
SKU: LEDT8574  
LENGTH LEGS: 45  
SHAFT DIAMETER: 10  
FRAME LENGTH: 16  
FRAME WIDTH: 13  
LENGTH BETWEEN LEGS: 22  
INSIDE DIAMETER: 12  
WIRE DIAMETER: 1.5  
RAW MATERIAL: EN 10270-3 1.4310  
COILS ON EACH BODY: 2.5  
MAXIMUM PERMITTED TORQUE: 800  
TORQUE ANGLE AT MN (?): 50

Product description:

- Double torsion spring according to DIN 2089
- Brand name: LESJÖFORS Springs
- Raw material: Stainless steel;EN 10270-3-1.4310
- Cycles guarantee : Infinite if working without reaching yield point
- All measures are in N. and mm.

{tab Delivering time}

{article 8 days delivering time} {text} {/article}

{tab Technical information}

Coming soon

{tab Other informations}

{/tabs}