

Product title:

Double torsion spring according to DIN 2089

Product image:

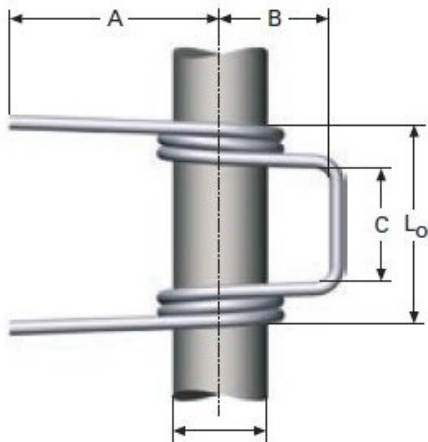

Product price:

€9.49

Product short description:

Muelle de doble torsion LEDT8555

Product features:

Location:

FREE ANGLE POSITION: A

SKU: LEDT8555

LENGTH LEGS: 25

SHAFT DIAMETER: 5

FRAME LENGTH: 8

FRAME WIDTH: 7.5

LENGTH BETWEEN LEGS: 13.5

INSIDE DIAMETER: 6

WIRE DIAMETER: 0.75

RAW MATERIAL: EN 10270-3 1.4310

COILS ON EACH BODY: 3

MAXIMUM PERMITTED TORQUE: 110

TORQUE ANGLE AT MN (?): 66

Product description:

- Double torsion spring according to DIN 2089
- Brand name: LESJÖFORS Springs
- Raw material: Stainless steel;EN 10270-3-1.4310
- Cycles guarantee : Infinite if working without reaching yield point
- All measures are in N. and mm.

{tab Delivering time}

{article 8 days delivering time} {text} {/article}

{tab Technical information}

Coming soon

Coming soon

{/tabs}